

# COBRA

## MT270K / LRH270K

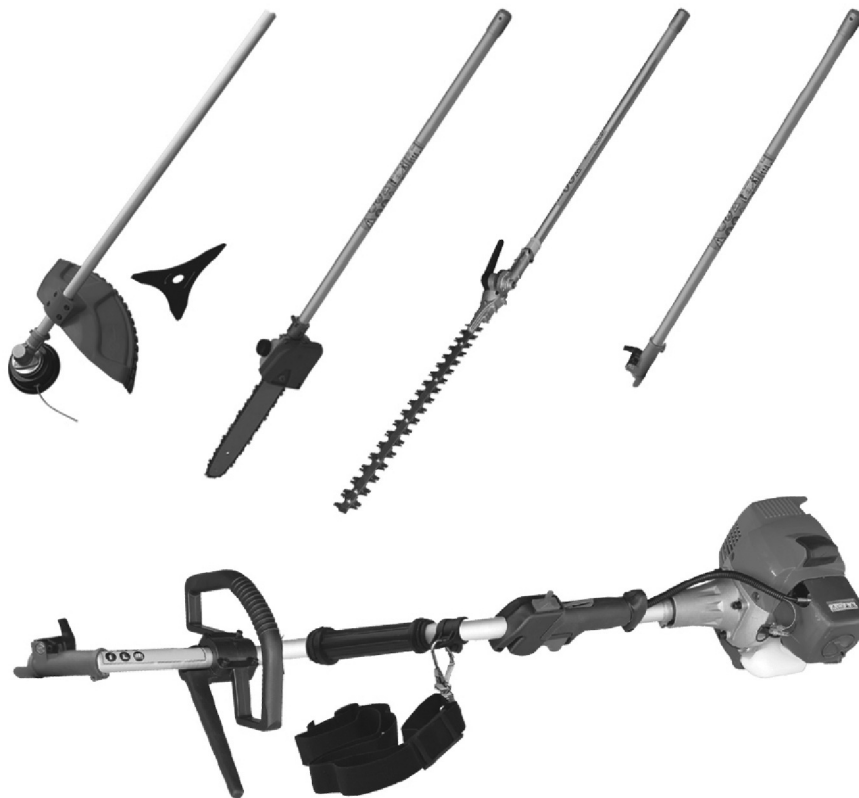

ASSEMBLY & OPERATING INSTRUCTIONS

# CONTENTS

ENGINE PART.....	1-16
BRUSH CUTTER.....	17-27
POLE PRUNER.....	28-39
HEDGE TRIMMER.....	40-49

## Attention Statements

Throughout this manual are special attention statements.

 **DANGER!**  
A statement preceded by the triangular attention symbol and the word "DANGER" indicates an imminently hazardous situation which, if not avoided, will result in death or serious injury!

 **DANGER!**  
A statement preceded by the triangular attention symbol and the word "WARNING" indicates a potentially hazardous situation which, if not avoided, COULD result in death or serious injury!

**CAUTION!**  
A statement preceded by the word "CAUTION" contains information that should be acted upon to avoid damage to the machine.

### **IMPORTANT!**

A statement preceded by the word "IMPORTANT" is one that possesses special significance.

-----  
**NOTE:**

A statement preceded by the word "NOTE" contains information that is handy to know and may make your job easier.

## Introduction

Long reach hedge trimmer 2600 is designed and built to deliver superior performance and reliability without compromise to quality, comfort, safety or durability.

### IMPORTANT!

The information contained in these instructions describes components available at the time of publication. While every attempt has been made to provide the latest information about your product, there may be some differences between your attachment and what is described here. We reserves the right to make changes to products without prior notice and without obligation to make alterations to components previously manufactured.

The procedures described in this manual are intended to help you get the most from your machine as well as to protect you and others from harm. these procedures are guidelines for safe operation under most conditions, and are not intended to replace any safety rules and/or laws that may be in force in your area.

If you have questions regarding your power tool, or if you do not understand something in this manual, your local dealer will be glad to assist you.

## Safety Precautions



**DANGER!**

**THE ARTICULATED HEDGE TRIMMER IS NOT INSULATED AGAINST ELECTRICAL SHOCK!**

Approaching or contacting electrical lines with the trimmer could cause death or serious injury. Keep the trimmer at least 10 meters away from electrical lines or branches that contact electrical lines.

An articulated hedge trimmer has the potential to do serious damage if misused, abused or mishandled. To reduce the risk of injury, you must maintain control at all times, and observe all safety precautions during operation. Never permit a person without training or instruction to operate this machine!

### NOTE!

For specific maintenance and safety information about you long reach Hedge trimmer T2600 Multipurpose Engine or long reach pruner P2600 power head, consult the owner's manual provided with it. If it has been lost or misplaced, contact us for a replacement.

## Operating Precautions



read and follow this manual, make sure anyone using the trimmer does likewise. Failure to do so could result in serious personal injury or machine failure. Keep this manual for future reference.



Never operate this tool or any other power equipment if you are tired, ill, or under the influence of alcohol, drugs, or any substance that could affect your ability or judgement.



Always wear a hard hat to reduce the risk of head injuries during operation of this machine. In addition, always wear eye and hearing protection. We recommend wearing a face shield as additional face and eye protection.



Keep bystanders at least 15 meters (50 feet) away from the operating trimmer to reduce the risk of being struck by falling objects or thrown debris.



Wear non-slip heavy-duty gloves to improve your grip on the trimmer handle. Wear sturdy footwear with non-slip soles to provide good footing. Steel-toes safety boots are recommended. Wear snug-fitting clothes that also permits freedom of movement.



Never cut off branches over your head. The cut-off branches may hit you and cause serious injury.

## Operating Precautions



### WARNING!

- Never permit a person without training or instruction to operate this machine.
- Always make sure the cutter attachment is properly installed and firmly tightened before operation.
- Never use a cracked or warped cutter or cutter bar: replace or repair before use.
- Before starting the engine, make sure the cutter is clear of all objects.
- Always stop the engine immediately and check for damage if you strike a foreign object or if the machine becomes tangled. do not operate with broken or damaged equipment.
- When cutting a branch that is under tension, be alert for spring-back so that you will not be struck by the moving branch.
- Stop the machine immediately if it suddenly begins to vibrate or shake. Inspect for broken, missing or improperly installed parts or attachments.
- Never smoke or light fires near the hedge trimmer. Keep the trimmer away from excessive heat. Engine fuel is very flammable and fire could lead to serious personal injury or property damage.-
- Never operate this machine or other power equipment if you are tired, ill, or under the influence of alcohol, drugs, or any other substance that could affect your ability of judgement. Do not operate the articulated hedge trimmer with the muffler removed.
- Make sure there is always good ventilation when operating the articulated hedge trimmer. Fumes from engine exhaust can cause serious injury or death. Never run the engine indoors!
- Make sure there are no missing or loose fasteners, and that the stop switch and throttle controls are working properly
- If a cutter should bind fast in a cut, shut off the engine immediately. Push the branch or tree to ease the bind and free the cutter.
- Make sure the cutters are correctly adjusted before operating the articulated hedge trimmer (see page 17 for cutter adjustment procedures). Never attempt cutter adjustment with the engine running!
- Make sure of no fuel leaking from Fuel tank, fuel cap, Fuel pipe and carburetor and other parts which fuel may leak. Repair the machine if fuel leaking, make sure no leaking again.

## Installing the Powerhead

1. Place the powerhead on a clean, flat surface, spark plug facing up.
2. Use the 4mm allen wrench to loosen the tube clamp as shown in figure 4.

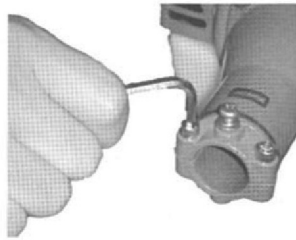

**Figure 4**

3. Slip off the protective covers from two ends of tube.

### CAUTION!

Do not force the lower tube into the powerhead! Excessive force can damage the components.

4. Push the lower tube towards the tube clamp and rotate it by hand to check that the mainshaft splines engage the powerhead, See Figure 5

5. Insert the lower tube into the tube clamp until it bottoms and align the positioning holes on the tube and clamp, then install the screw.

6. Fasten the clamp securely with 2 clamp screws.

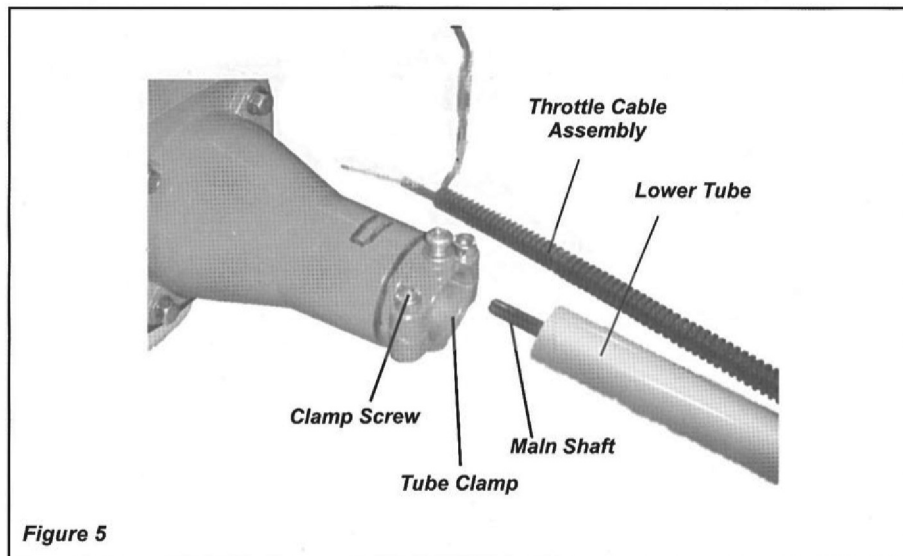

**Figure 5**

## Connecting the Throttle Cable

1. Remove the air cleaner cover.
2. Connect the end of the throttle cable to the joint on the top of the carburetor. See Figure 6, figure 7.



*Figure 6*

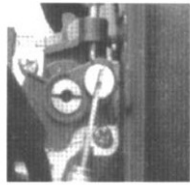

*Figure 7*

## Connecting switch wires

connect the switch wires between the engine and the main unit. Pair the wires of the same color. See figure 8.

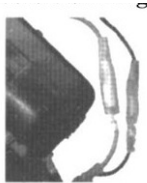

*Figure 8*

## Adjusting the Throttle cable

1. Loosen the throttle cable nut at fan cover as shown in figure 9.

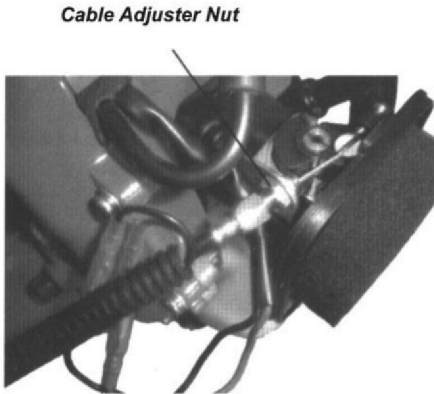

*figure 9*

---

2. Adjust the throttle cable adjuster nuts until you achieve a free play on the throttle trigger of about 6mm. See Figure 10.

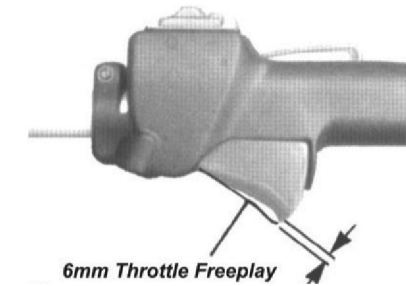

*figure 10*

---

When 6mm free play is achieved, tighten the two 10mm throttle cable nuts. When the throttle cable is correctly adjusted, and the throttle trigger is fully depressed (full throttle), the throttle will contact the stop on the throttle body. See Figure 11.

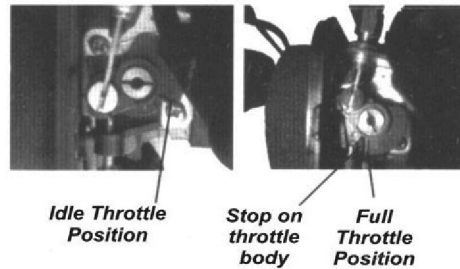

*figure 11*

---

.....  
A dab of Never-Seez TM or equivalent eases removal.  
.....

4. Replace the air cleaner cover.



## Assembling the Tube Sections

1. Place the powerhead/lower tube assembly and the upper tube assembly on a clean, flat surface so that both assemblies fit end to end. The powerhead/lower tube assembly should be facing up, and the upper tube assembly should be positioned with the latch protector facing up.

### CAUTION!

Keep the open end of the tubes clean and free of impurities!

2. Loosen the coupler screw.

3. Depress the latch and insert the powerhead/lower tube assembly into the coupler until it bottoms. Release the latch. Rock the upper tube assembly back and forth until you are sure it snaps in place by the coupler lock. See Figure 12.

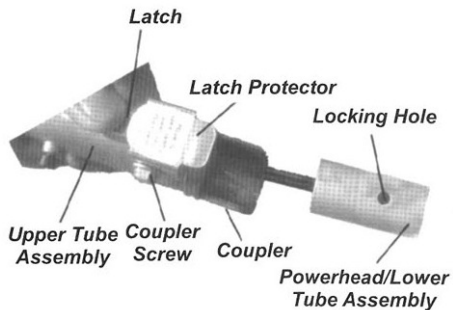

Figure 12

4. When the two tube halves are locked together, slide the latch protector into groove of latch, then tighten the coupler screw. See Figure 13.

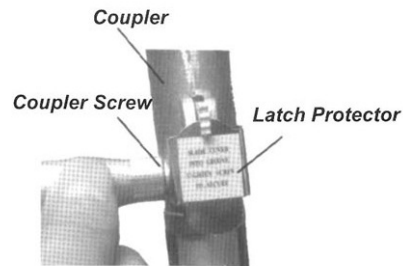

Figure 13

## Disassembling The Pole sections

1. With the pole pruner on a clean, flat surface, loosen the coupler screw. slide the latch protector out of groove of latch.

2. Depress the latch. This release the coupler lock. See Figure 14.

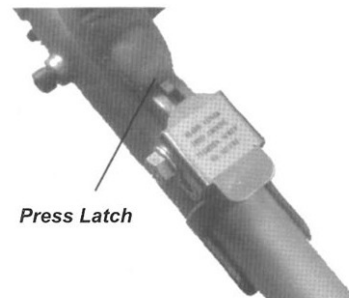

Figure 14

3. Pull the upper tube assembly out of the coupler

## Mixing Fuel

### CAUTION!

This engine is to be operated on a 25:1 mixture consisting of unleaded gasoline and 2-cycle mixing oil only.

Some gasolines contain alcohol as an oxygenate. Oxygenated fuels may cause increased operating temperatures. Under certain conditions alcohol-based fuels may also reduce the lubricating qualities of some mixing oils. Never use any fuel containing more than 10% alcohol by volume! When an oxygenated fuel must be used, fuel containing an oxygenate such as MTBE is preferred over an alcohol based fuel.

Generic oils and some outboard motor oils may not be intended for use in high-performance air cooled 2-cycle engines, and should never be used in a this engine!

- Use only fresh, clean unleaded gasoline with an octane rating of 87 or above.
- Mix all fuel with 2-cycle Engine Oil at a gasoline/oil ratio of 25:1.

### IMPORTANT

Mix only enough fuel for your immediate needs! If fuel must be stored longer than 30 days, it should first be treated with a stabilizer such as StaBil™



### WARNING!

Always minimize the risk of fire when handling fuel!

- Always allow the pruner to cool before refueling!
- Wipe all spilled fuel and move the pruner at least 3 meters (10 feet) from the fueling point before restarting!
- Never smoke or light any fires near the pruner or fuels!
- Never place any flammable material near the engine muffler!
- Never operate the engine without the muffler and spark arrestor in place and properly functioning!
- Never operate this machine if fuel system components are damaged or are leaking.

1. Place the pruner on a flat, level surface.
2. Clear any dirt or other debris from around the fuel filler cap.
3. Remove the fuel cap, and fill the fuel tank with clean, fresh fuel mixture.
4. Install and firmly tighten the fuel cap.
5. Wipe up any spilled fuel from the powerhead before restarting.

## Starting A Cold Engine-Restarting After Refueling

Control Positions (cold engine)

1. Set the throttle trigger to "Fast idle" as follows (Figure 24):

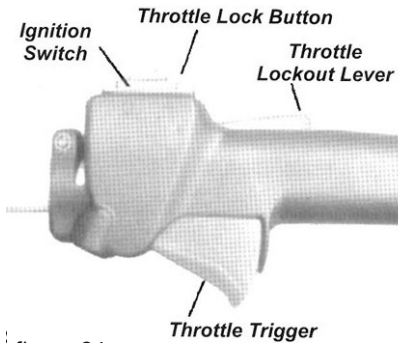

figure 24

- Depress and hold the throttle lockout lever.
- squeeze and hold the throttle trigger.
- Depress the throttle lock button.
- While holding down the throttle lock button, release the throttle trigger and throttle lockout lever.
- Release the throttle lock button.

### IMPORTANT

Engine ignition is controlled by a two-position START-STOP switch mounted on the throttle body, typically labeled "I" for START and "O" for STOP.

2. Slide the ignition switch to the "I" (start) Position. See Figure 25.



figure 25

3. Prime the engine by depressing the carburetor primer bulb four or five times, See Figure 26. You should be able to see fuel inside the bulb.

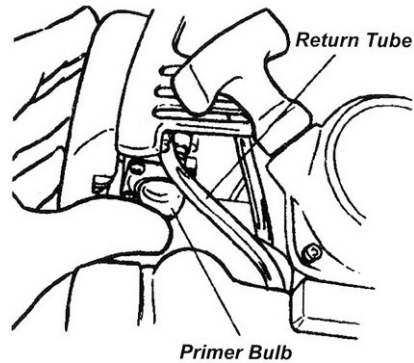

figure 26

4. Choke the engine by moving the choke lever up to the "closed" position. See Figure 27.

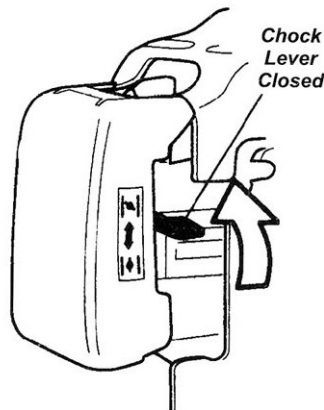

figure 27

Control Positions (warm engine)

1. Set the throttle trigger to "fast idle" (see Step 1 above).
2. Slide the ignition switch to the "I" (START) position.
3. Moving the choke lever down to the "open" position.

## Cranking The Engine



### WARNING!

When starting the engine, make sure the cutting attachment is well clear of bystanders, pets or objects. The attachment may rotate during startup.

### CAUTION!

Never operate the pole pruner unless a cutting attachment is installed.

1. Place the unit firmly on the ground, making sure it is stable and that the cutting attachment is free and clear of any bystanders or objects. Hold onto the hand grip on the outer tube with your left hand grasp the starter rope handle with your right hand. See Figure 28.



Figure 28

### CAUTION!

The recoil starter can be damaged by abuse.

- Always engage the starter before attempting to crank the engine.
- Never pull the starter cord to its full length.
- Always rewind the starter cord slowly.

2. Pull the starter handle slowly until you feel the starter engage.

3. Pull the starter handle quickly to start the engine.

### When The Engine Starts Or Fires

Open the choke by moving the choke lever down. See Figure 29.

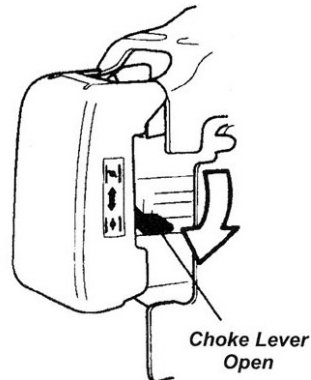

Figure 29



### WARNING!

The cutting attachment will engage and rotate as the engine starts and accelerates.

If the engine did not continue to run, repeat the appropriate cranking procedure (warm or cold engine).

When the engine starts clear excess fuel from the combustion chamber by revving the engine several times with the throttle trigger (operating the trigger will automatically disengage the "fast idle" setting).

#### If The engine Fails To Start

Repeat the appropriate cranking procedure (warm or cold engine). If the engine fails to start after repeated attempts, the engine is likely flooded. Proceed to the following procedure.

#### Starting A Flooded Engine

1. Disconnect the spark plug lead, and then use the spark plug wrench to remove the spark lug (turn counterclockwise to remove). See Figure 30.

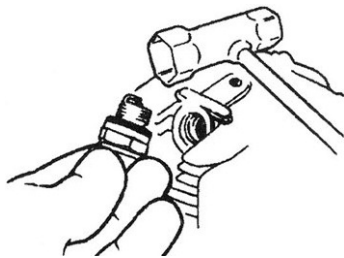

Figure 30

If the spark plug is fouled or soaked with fuel, clean the lug as necessary.

2. Open the choke (Figure 31) and fully depress the throttle trigger with your left hand, then pull the starter handle rapidly with your right hand to clear excess fuel from the combustion chamber.

### CAUTION!

Incorrect spark plug installation can result in serious engine damage.

3. Reinstall the spark plug and tighten it firmly. If a torque wrench is available, torque the spark plug to 16.7-18.6 N.m.

4. Repeat the starting procedure for a warm engine.

5. If the engine still fails to start, refer to the troubles shooting section near the end of the manual.

#### Stopping The Engine



### WARNING!

The cutting attachment can continue rotating after the engine is switched off!

1. Cool the engine by allowing it to idle for two or three minutes.

2. Slide the ignition switch to the "O" or STOP position. See Figure 31.



Figure 31

## Adjusting The Carburetor



### WARNING!

The cutting attachment must never rotate at engine idle speed.

The engine must return to idle speed whenever the throttle trigger is released. Idle speed is adjustable and must be set low enough to permit the engine clutch to disengage the chain saw when throttle trigger is released.

### Check and Adjust Idle Speed

1. Start the engine and allow it to idle two or three minutes, or until it warms up.

If the cutting attachment rotates at engine idle, reduce idle speed by turning the idle adjusting screw counter clockwise as necessary. See Figure 32.

### IMPORTANT

Use a tachometer, if one is available, to set engine idle. Standard idle speed is:

$$300 \pm 200 \text{rpm}$$

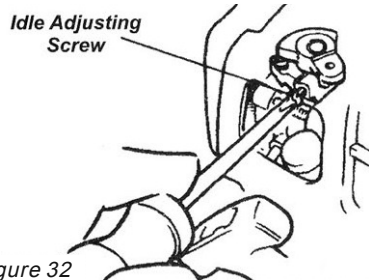

Figure 32

3. If the engine is stalling and won't idle, increase idle speed by turning the idle adjustment screw clockwise.

### NOTE

The mixture of the carburetor on this unit cannot be adjusted.

## Safety Operation

This machine is designed especially for cutting branches.

Never use this machine for any other purposes. Never try to cut stones, metals, plastics or any other hard objects.

Using for other purposes than cutting branches may damage the machine or cause serious injury.

### Preparations

- Wear suitable protective clothing and equipment-see section "safety Precautions".
- Choose the best work position for safety against the falling object (Branch etc)
- Start the engine.
- Put on the strap.

Never stand directly underneath the branch you are cutting-be wary of falling branches. Note that a branch may spring back at you after it hits the ground.

### Cutting sequence:

To allow branches a free fall, always cut the lower branches first. Prune heavy branches (Large diameter) in several controllable pieces.

### Working position:

Hold the control handle with your right hand, and the shaft with your left hand. Your left arm should be extended to the most comfortable position.

The shaft should always be held at an angle of 60° or less.

## General maintenance



### WARNING!

Before performing any maintenance, repair, or cleaning work on the machine, make sure the engine and cutting attachment are completely stopped. Disconnect the spark plug wire before performing service or maintenance work.



### WARNING!

Non-standard parts may not operate properly with your unit and may cause damage and lead to personal injury.

### Muffler



### WARNING!

Operating the engine without a muffler or with a muffler that is damaged or improperly sufficiently to lead to hearing loss.

This machine must never be operated with a faulty or missing spark arrestor or muffler is well secured and in good condition. A worn or damaged muffler is a fire hazard and may also cause hearing loss.

### SPARK PLUG

Keep the spark plug and wire connections tight and clean.

## Daily maintenance

Prior to each work day, perform the following:

- Remove all dirt and debris from the engine, check the cooling fins and air cleaner for clogging, and clean as necessary. see Figure 33.

*Keep cooling fins clean*

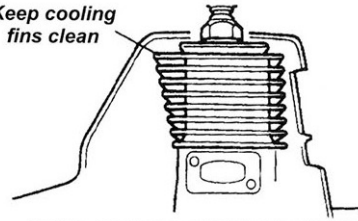

Figure 33

- Carefully remove any accumulating of dirt or debris from the muffler and fuel tank first build-up in these areas can lead to engine overheating fire or premature wear.
- Check for loose or missing screws or components. Make sure the cutting attachment is free of debris and securely fastened.
- Check the entire machine for leaking fuel or grease.
- Make sure nuts, bolts and screws (except carburetor adjusting screws) and tight.

## 10-Hour Maintenance

### CAUTION!

Do not operate the machine if the air cleaner or element is damaged, or if the element is wet or water soaked.

Every 10 hours of operation: (more frequently in dusty or dirty conditions):  
remove the air cleaner element from the air cleaner housing and clean it thoroughly with soap and water. Rinse and dry thoroughly. Add a few drops of oil and work it in, then reassemble the element. See Figure 34.

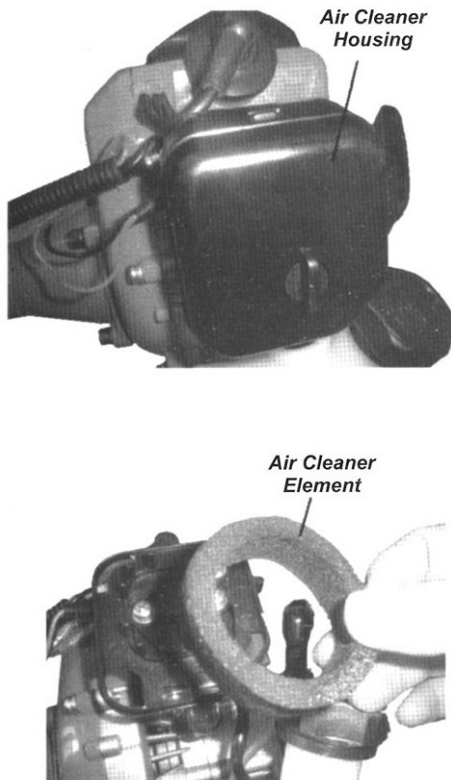

Figure 34

## 10/15-Hour Maintenance

### CAUTION!

Before removing the spark plug, clean the area around the plug to prevent dirt and dust from getting into the engine's internal parts.

Every 10 to 15 hours of operation: remove and clean the spark plug. See Figure 35. Adjust the spark plug electrode gap to 0.6~0.7mm. Replace the spark plug as necessary.

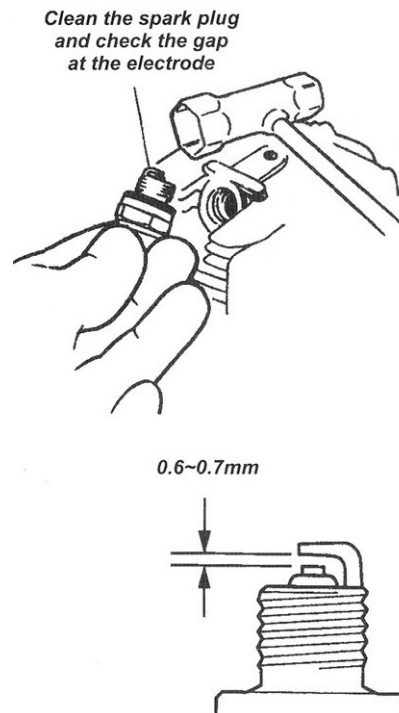

Figure 35



## Specifications

Dry Weight (Without Bar/Chain).....	5.9kg	Stopping Method.....	Slide switch
Engine Type.....	2-cycle, air-cooled, vertical-cylinder	Transmission Type.....	Automatic, centrifugal clutch with bevel gear
BorexStroke.....	34x28 mm	Oil Tank Capacity.....	400ml
Displacement.....	25.4cm <sup>3</sup>	Gearcase Ratio.....	1.06:1
Engine speed at Idle.....	3000min <sup>-1</sup>	Standard Equipment.....	tool kit containing a spark plug wrench, 4mm allen wrench and 8mm x 10mm spanner, strap, chain cover phillips screwdriver
Maximum engine speed.....	7500min <sup>-1</sup>		
Maximum Output.....	0.7kW@8500min <sup>-1</sup>		
Fuel/Oil Ratio.....	25:1 with 2-cycle Engine Oil		
Fuel Tank Capacity.....	600ml		
Carburetor Type.....	Diaphragm type		
Ignition.....	Flywheel magneto CDI system		
Spark plug.....	NGK		
Air Filter.....	Semi-wet, quick-remove/install		
Starting Method.....	Recoil		
Cooling System.....	Forced air		

Sound Pressure Level*		91 dB (A)
Sound Power Level*		106 dB (A)
Vibration Level*	Idling (Front/Rear)	2.32/2.78 m/s <sup>2</sup>
	Racing (Front/Rear)	3.64/3.89 m/s <sup>2</sup>

\*Sound Pressure Level: in accordance with ISO 11680-1 (Annex B)

\*Sound Power Level: in accordance with ISO 11680-1 (Annex B)

\*Vibration Level: in accordance with ISO 11680-1 (Annex C)

## BRUSH CUTTER

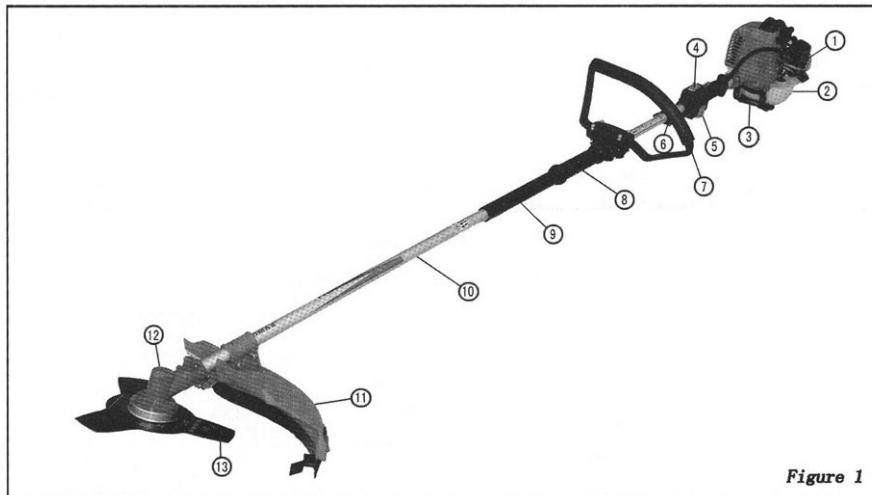

### 1.PARTS LOCATION

See figure 1

- 1.Air cleaner
- 2.Fuel tank
- 3.Clutch coupler system
- 4.Ignition switch
- 5.Throttle trigger
- 6.Hanger
- 7.handle A
- 8.Handle B
- 9.Handle C
- 10.Outer pipe
- 11Debris shield
- 12.Gearcase
- 13.Blade

## 2. Warning labels on the machine

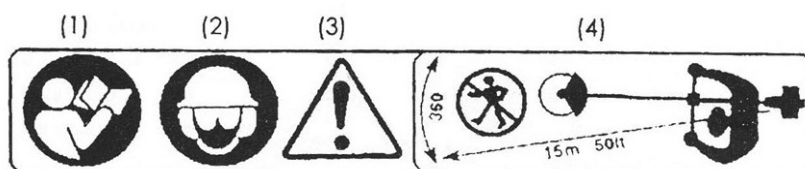

- (1) Read owner's manual before operation this machine
- (2) Wear head, eye and ear protection
- (3) Warning/attention
- (4) Keep all children, bystanders and helpers 15 meters away from the brush cutter.

### **IMPORTANT**

If warning seals peel off or become soiled and impossible to read, you should contact the dealer from which you purchased the product to order new seals and offer the new seal in the required location.

### **WARNING**

Never remodel your brush cutter.  
We won't warrant the machine. If you use the remodeled brush cutter or you don't observe the proper usage written in the manual.

## 3. Symbols on the machine

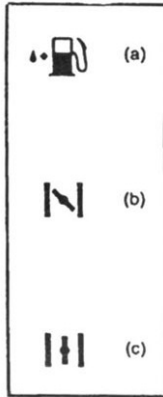

For safe operation and maintenance, symbols are carved in relief on the machine. According to these indications please be careful not to t ake mistake

(a)The port to refuel the "mix gasoline"

Position: fuel tank cap

(b)The direction to close the choke

Position:air cleaner cover

(c)The direction to open the choke

Position:air cleaner cover

#### 4. Safety precautions Before using the machine



A. Read the owner's manual carefully to understand how to operation this unit properly.

B. This product has been designed for use in cutting grass, and it should never be used for any other purpose.

C. You should never use the machine when under the influence of alcohol, when suffering from exhaustion or lack of sleep when suffering from drowsiness as a result of having taken cold medicine, or at any other time when a possibility exists that your judgment might be impaired or that you might not be able to operate the brush cutter properly and in a safe manner.



D. Avoid running the engine indoors. The exhaust gases contain harmful carbon monoxide.



E. Never use your brush cutter under circumstance like those described below.

1. When the ground is slippery or when other conditions exist which might make it impossible to maintain a steady posture while using the brush cutter.

2. At night at times of heavy fog. Or at any other time times when your field or vision might be limited and it would be difficult to gain a clear view of area.



3. During rain storms, during lightning storms at times of strong or gale-force winds,or at any other times when weather condition might make it unsafe to use this machine.

F. When using this machine fo the first time, before beginning actual work learn to handle brush cutter from skilled workers.

G. Lack of sleep tiredness, or physical exhaustion result in lower attention spans and this in fact can lead to accident and injury.limit the amount of time which the bush cutter is to be used continuously to somewhere around 30-40 minutes per session, and take 10-20 minutes of rest between work session. Also try to keep the total amount of work performed in a single day under 2 hours or less.

H. Be sure to keep this manual handy so you might refer to it later or whenever the questions arise.

- I. Always be sure to include this manual when selling, lending, or otherwise transferring the ownership of this product.
- J. Never allow children or anyone unable to fully understand the directions given in this manual to use this brush cutter.

■ **WORKING GEAR AND CLOTHING**

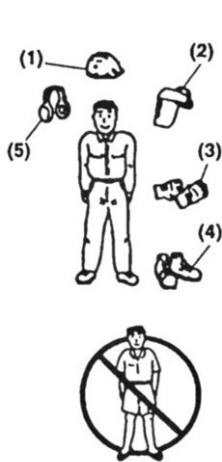

A. When using your brush cutter, you should wear proper clothing and protective equipment as follows.

1. Helmet
2. Protection goggles or face protector
3. Thick work gloves
4. Non-slip-sole working boots
5. Ear protector

B. And you should carry with things as follows

1. Attached tools and files
2. Properly reserved fuel
3. Spare blade
4. Things to notify your working area (tape, warning signs)
5. Whistle (for collaboration or emergency)
6. Hatchet or saw (for removal of obstacles)

C. Never use your brush cutter when you are wearing pants with loose cuffs, when wearing sandals, or even barefoot.

■ **WARNING CONSIDERING HANDLING OF FUEL**



A. The engine of this product is designed to run on a mixed fuel, which contains highly flammable gasoline. You should never store cans of fuel or refill the fuel tank in any place where there is a boiler, stove, wood fire, electrical sparks, welding sparks, or any other source of heat or fire which might ignite the fuel.

B. Smoking while operating the brush cutter or refilling its fuel tank is extremely dangerous. Always be sure to keep lit cigarette away from brush cutter at all times.

C. When refilling the tank always turn off the engine first and take a careful look around to make sure that there are no sparks or open flames anywhere near by before refueling.

D. If any fuel spillage occurs during refueling, use a dry rug to wipe up spills before turning the engine back on again.

E. After refueling screw the fuel cap back tightly onto the fuel tank and then carry the brush cutter to a spot 3 meters more away from where it refueled before turning on the

■ **THINGS TO CHECK BEFORE USING YOUR BRUSH CUTTER**

A. Before beginning work, look around carefully to get a feel for the shape of land, or grass to be trimmed and whether or not there are any obstacles which might get in the way while working, and remove any

Obstacles, which can be cleared away.

B. The area within a perimeter of 15m of the person using the brush cutter should be considered a hazardous area into which no one should enter while the brush cutter is in use, and when necessary yellow warning rope, warning signs should be placed around work area. When work is to be performed simultaneously by two or more persons, always check the presence and locations of others so as to maintain a distance each person sufficient to ensure safety.

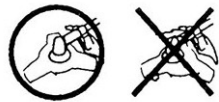

C. Make sure that there are no loose screws or bolt, fuel leaks, ruptures, dents, or any other problems, which might interfere with safety operation. Be especially careful to check that there is nothing wrong with the blades or with the joints by which the blades are attached to the brush cutter.



D. Never use blades that are bent, warped cracked, broken or damaged in any way.



E. Keep the blade always sharp.

F. Filing the cutting edge, keep the end corner sharp and round the root of the edge.

G. Check the bolt to fasten the blade and be sure the blade turn smoothly without abnormal noise.

#### NOTES ON STARTING THE ENGINE

1. Take a careful look around to make sure that obstacles exist within a perimeter of 15m or less around brush cutter.

2. Place the brush cutter onto the ground in a flat clear area and hold it firmly in place so as to ensure that neither the blades nor the throttle came into contact with any obstacles when the engine start up.



3. Place the throttle into the idling position when starting the engine.

4. After starting the engine. Of the blades continue to rotate even after throttle has been move fully back fully turn off the engine and check the throttle wire and other parts.

#### KICKBACK SAFETY PRECAUTIONS

A dangerous reaction may occur when the spinning blade contact a solid object in the critical area. It is called kick back, as a result, the operator can lose control of the unit which can cause serious or total injury.

Avoid kickback; observe the safety precautions below strictly.

1. Before beginning work, clear your working area and remove grass around the obstacles.

2. When using your brush cutter, do not grip other parts except the handles.

- 
3. When using your brush cutter, never take your eyes off. If you need to, place your throttle into idling position.
  4. When using your brush cutter. Do not let the unit get closer to your feet nor raise the unit above your waist.

■ **NOTES ON TRANSPORTATION**

1. Make sure the appropriate blade is in place.
2. When transportation by car, fix the unit firmly using a rope. Do not transport by bicycle or motorcycle because it is dangerous.
3. Never transport brush cutter in a rough road over long distance without first removing all fuel from fuel tank, as doing so might cause fuel to leak from tank.

■ **OPERATION SAFETY PRECAUTIONS**

1. Grip the handle on the brush cutter firmly with both hands. If you suspend the work, place the throttle into the idling position.
2. Always be sure to maintain a steady, even posture while working.



3. Maintain the speed of the engine at the level required to perform cutting work, and never raise speed of the engine above the level necessary.



4. If the grass gets caught in the blade during operation, or if you need to check the unit or refuel the tank, always be sure to turn off the engine.
5. If the blade touches a hard object like a stone, stop the engine immediately and check if something is wrong with the blade, if so, replace the blade with a new one.



6. If someone calls out while working, always be sure to turn off the engine before turning around.
7. Never touch the spark plug or plug cord while the engine is in operation. Doing so may result in being subjected to an electrical shock.

8. Never touch the muffler, spark plug or other metallic parts of the engine while the engine is in operation or immediately after shutting down the engine. Doing so may result in serious burns.
9. When you finish cutting in one location and wish to continue work in another spot, turn off the engine and turn the unit so the blade faces away from your body.

■ **MAINTENANCE SAFETY PRECAUTION**

1. Perform the maintenance and checking operations described in this manual at regular intervals. If any parts must be replaced or any maintenance or repair work not described in this manual must be performed. Please contact a representative from the nearest store authorized servicing dealer for assistance.
2. Under no circumstances should you ever take apart the brush cutter or alter it in any way. Doing so might result in the brush cutter becoming damaged during operation or the brush cutter becoming unable to operate properly.

- 
3. Always be sure to turn off engine before performing any maintenance or checking procedures
  4. When sharpening, removing, or reattaching the blade proper tools and equipment to prevent injury.
  5. When replacing blade or any other parts or when replacing the oil or any lubricants, always be sure to use only products or products which have been certified by for use with the brush cutter.

## 5. SET UP

### HANDLE

Fix Handle with four bolts  
see figure 9



Figure 9

### INSTALL GEARCASE

1. Loosen two clamp screws and remove one index screw
2. Push the pipe towards gearcase and rotate it by hand to check that the mainshaft splines engage the powerhead.
3. Insert the pipe into gear case until it bottoms and align the positioning holes on the pipe and gearcase. then replace the index screw and tighten.
5. Fasten the pipe clamp securely with two clamp screws  
see figure 10

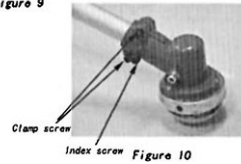



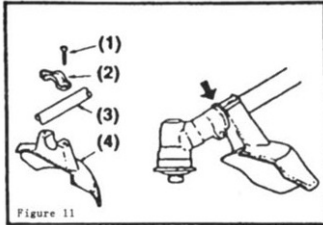

#### ■ SAFETY GUARD

Attach the safety guard to the gear case and fix it with the clamp and 2 bolts (M5\*25) securely. (Figure 11)

- (1) Bolt
- (2) Clamp
- (3) Main pipe
- (4) Safety guard

#### ■ INSTALLING THE METAL BLADE (Figure 12)

1. Set the inner holder to the gear shaft, and turn to fix with the attached L-shaped bar.
2. Put the blade on the inner holder with letters to the gear case, and match correctly the hole of the blade to the projection of the inner holder.
3. Set the outer holder to the gear shaft with the hollowed face to the blade.

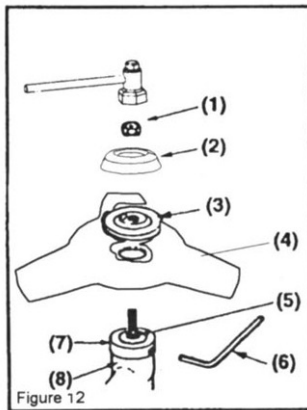

4. Put the attached bolt cover on the outer holder and secure it with the bolt (left screw) together with the spring washer and the washer.

- (1) Nut
- (2) Outer holder 1
- (3) Outer holder 2
- (4) Blade
- (5) Gear shaft
- (6) Bar
- (7) Inner holder
- (8) Gear case

#### ■ INSTALLING THE NYLON CUTTER(OPTION) (Figure 13)

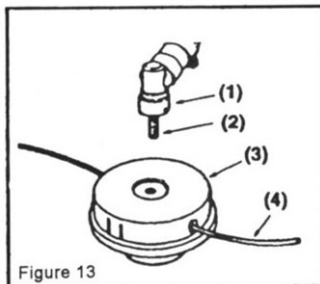

1. Set correctly the inner holder and the outer holder to the gear shaft.
2. Screw the attached bolt (M8 Left) into the gear shaft and secure it with the spanner.
3. Screw the nylon cutter into the bolt by fixing the inner holder with the L-shaped bar and tighten it manually.

#### NOTE

Keep bolts and washers to install the blade carefully so as not to lose them.

- (1) Gear Case
- (2) Bolt
- (3) Nylon cutter
- (4) Nylon cord

## Stopping The engine

### WARNING!

The cutting attachment can continue rotating after the engine is switched off!

1. Cooling the engine by allowing it to idle for two or three minutes.
2. Slide the ignition switch to the "O" or STOP position. See Figure 21

**To Wear the Strap** See Figure 22

1. Hook the strap hook to hanger on the outer pipe.
2. Wear the strap so that the hook stays at your right hand side.
3. Adjust the length of the strap so that you can hold and operate machine will be released from the strap.

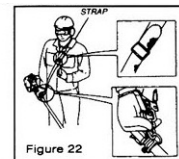

**Emergency Release** See Figure 23

In case of emergency strongly pull the white tab at the hook. The machine will be released from the strap.

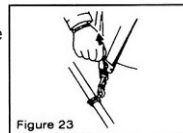

## ■ CUTTING OPERATION

### METAL BLADE USAGE

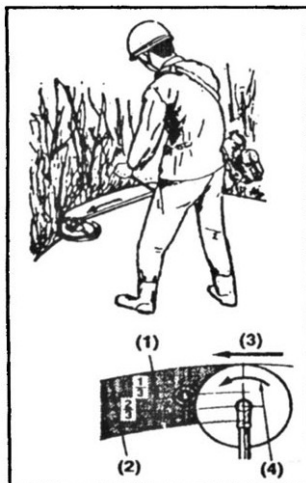

- ☆ Always cut by guiding the head from your right to left.
- ☆ A metal blade cut best up to the point 1/3 from the edge. Use that area for cutting shrubs, tough and thick weeds. For cutting young grass, you can use up to 2/3 from the tip of blade.
- ☆ Adjust the engine speed according to the cutting objects. Cut the young grass at middle speed, and cut shrubs or tough and thick weeds at high speed.

- (1) For branches and trees
- (2) For grass and weeds
- (3) Direction of cutting
- (4) Direction of rotation

### IMPORTANT

Operating at low speed makes it easier for grass, weeds, or twigs to become caught up in the blades, and also it makes the shaft and clutch wear down more quickly.

### NYLON CUTTER USAGE

- ☆ Nylon cord consumes large power. Please note that the engine rotation speed in operation should be 50% as large as when using metal blade.
- ☆ Nylon cutter cuts grass with the power of cord rotation. If you try to cut grass for the length of cord at one time, rotation speed becomes lower due to resistance and you cannot cut well. In case of large resistance, get the nylon cutter away from grass once, make the rotation speed higher, and cut a small amount of grass at one time.
- ☆ If you try to cut grass by swinging the brush cutter in the reverse way (from left to right), scraps fly in the direction away from the body. You can avoid getting your clothes dirty.

---

## 8. MAINTENANCE

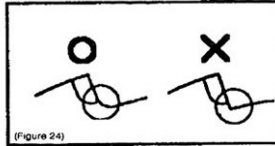

(Figure 24)

### BLADE

Sharpen each cutting edge and make sure the bottom corner is rounded. (figure 24)

Do not cool the blade with water in case of using grinder. It may cause cracks on blade.

**AFTER 25 HOURS OF USE**

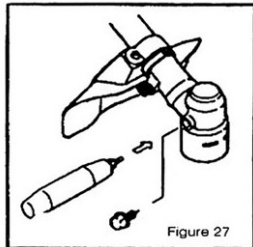

Figure 27

### GEAR CASE

Supply multi-purpose grease of every 25 hours of use. Remove the cutter holders to arrange for old grease to exit. (figure 27)

---

## MAINTENANCE BEFORE STORAGE

1. Brushing off dirt from the machine, check damage or slack of each part. If you find out abnormalities, repair them for the next use.
2. Extract fuel from the tank, and loose the drain screw of the float cabin to extract fuel, turn on the engine, and leave it running until it stops naturally.
3. Remove the spark plug and put in 1-2cc of 2-cycle oil in the engine. Draw the starter rope 2-3 times, set the plug back, and stop it at the contraction position.
4. Apply anti-rust oil to the metal parts such as the throttle wire, put the cover on the blade, and keep it indoor avoiding dampness.

## 9. SPECIFICATION

Name		Brush cutter B250	Grass trimmer G250
Specification			
Handle type		Loop	Loop
Power transmission method		Automatic centrifugal clutch, spiral bevel gear	
Applied blade		Metal blade	Nylon cutter
Blade rotation direction		Counterclockwise(from operator's view)	Counterclockwise(from operator's view)
Outward size(L*W*H)(mm)		2040^380^330	2040^380^330
Weight(kg)		6.5	6.5
Engine	Type	Single cylinder air cooling 2-cycle gasoline engine	
	Displacement	25.4CC	
	Max. output	0.85kw at 8000rpm	
	Max. engine speed	11000rpm	
	Engine speed at idle	3000rpm±200rpm	
	Carburetor	Diaphragm type	
	Starting method	Recoil	
	Fuel	Mixture(gasoline:2-cycle engine oil) 25:1	
	Stopping method	Slide switch	
Fuel tank capacity		700CC	

## POLE PRUNER

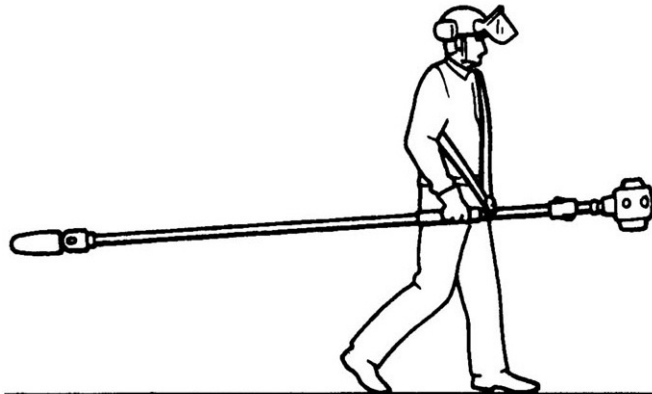

**Figure 1**

### CAUTION!

- Always maintain this pole pruner according to the this owner's manual and follow the recommended scheduled maintenance.
- Never modify or disable any of the pole pruner's safety devices.
- Always use genuine parts and accessories when repairing or maintaining this machine.
- Do not make unauthorized modifications or substitutions to the guide bar or chain .
- Never allow the engine to run at high RPM without a load , Doing so could damage the engine.
- When transporting the pruner in a vehicle , tie it down securely to prevent damage and fuel spillage.
- Always stop the engine and allow it to cool before refueling. Avoid overfilling and wipe off any fuel that may have spilled .
- Never place flammable material close to the engine muffler and never run the engine without the spark arrestor screen in place.
- Always clear your work area of trash or hidden debris to help ensure good footing .
- Keep the saw chain sharp and properly adjusted.
- Keep the pruner as clean as possible . Keep it free of loose vegetation , mud, etc .

## Operating the Pruner

### To Wear the strap

1. Hook the strap hook to the hanger on the outer pipe.
2. Wear the strap so that the hook stays at your right hand side
3. Adjust the length of the strap so that you can hold and operate the machine comfortably.

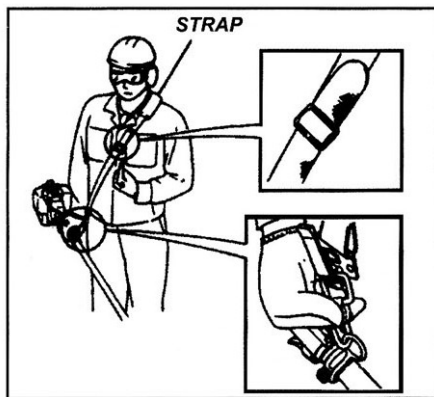

*Always wear eye and Hearing protection . manufacturer recommends wearing a face shield as additional face and eye protection .*

*Always wear a hard hat to reduce the risk of head injuries during operation of this machine.*

*Wear nonslip heavy-duty work gloves to improve your grip on the pole pruner handle. Wear snug-fitting clothes that. Also permits freedom of movement. NEVER wear shorts!*

*Wear sturdy footwear with nonslip soles to provide good footing . Steel-toes safety boots are recommended.*

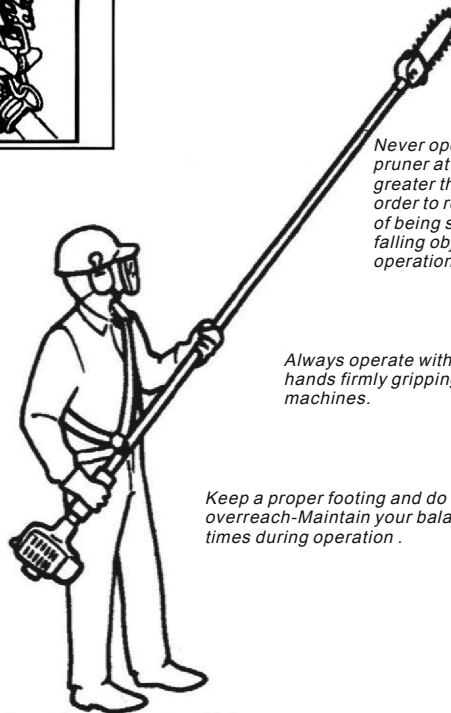

*Never operate the pruner at an angle greater than 60.c in order to reduce the risk of being struck by falling objects during operation.*

*Always operate with both hands firmly gripping the machines.*

*Keep a proper footing and do not overreach-Maintain your balance at all times during operation .*

*Keep bystanders at least 15 meters (50feet) away from the operating pruner to reduce the risk of being struck by falling objects or thrown debris,*

**Figure 2**

### Emergency Release

In case of emergency , strongly pull the white tab at the hook . The machine will be released from the strap.

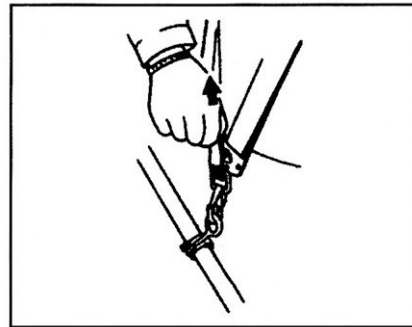

## Product Description

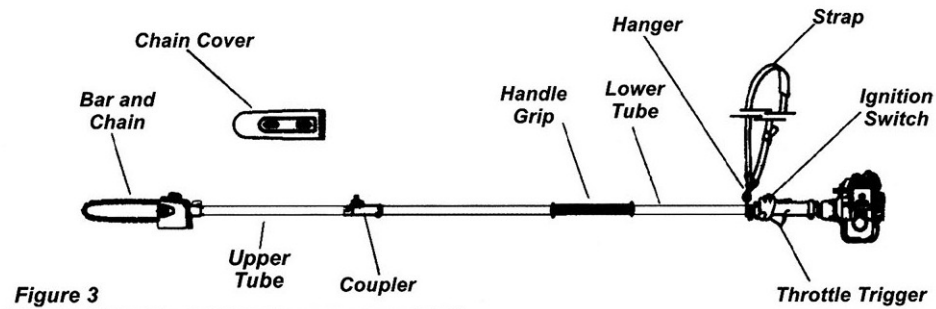
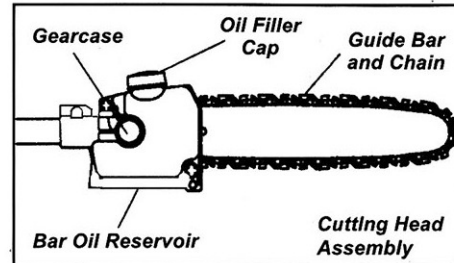
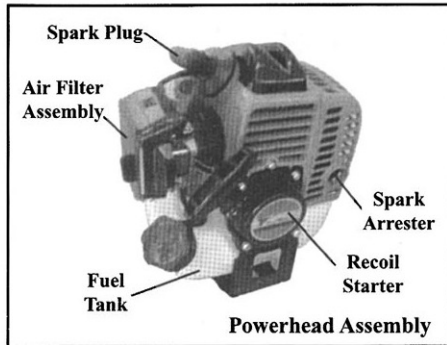

### Prior To Assembly

Using Figure 3 as a guide, familiarize yourself with the 2600 pole pruner and its various components. Understanding your machine helps ensure top performance, longer service life, and safer operation. Before assembling, make sure you have all the components required for a complete unit:

- Powerhead assembly
- Lower tube assembly
- Upper tube/saw assembly, chain and guide bar
- Kit with this manual and tool kit for routine maintenance
- Chain cover

Carefully inspect all components for damage.

### IMPORTANT

The terms "left-hand", and "LH"; "right", "right-hand", and "RH", "front" and "rear" refer to directions as viewed by the operator during normal operation.



### WARNING!

Do not make unauthorized modifications or alterations to your pruner or its components.

## Use unit without upper tube

If the lower tube assembly is long enough, you can use it only without upper tube according to the working condition.  
Operate as follows:

1. Follow “disassembling the pole sections” section to remove the upper tube/coupler assembly from gearcase.
2. Follow “assembling the pole sections” section to assemble the gearcase onto the lower tube assembly. See figure 15.

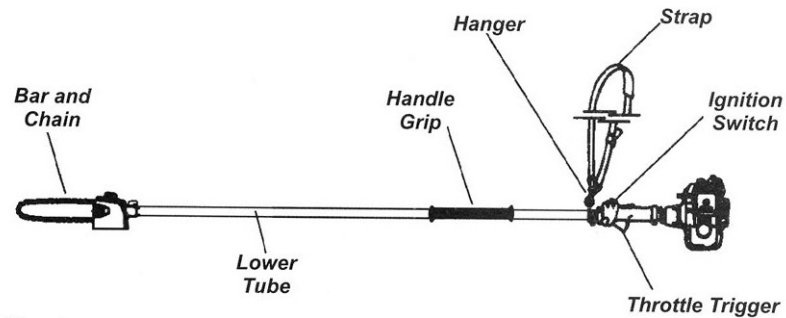

**Figure 15**

## Specifications

Cutter attachment weight..... 1.8kg  
Blade length  
Long Model..... 560mm/22in  
Short Model..... 460mm/22in  
Cutter drive..... Spur gear  
Gear lubricant..... Lithium based grease  
Tool kit contents..... Combination  
Wrench with 13mm+19mm  
Sockets/flat blade screwdriver 4mm-hex  
Wrench, and 8mm+10mm spanner



## Installing and Adjusting the Bar and Chain

### Installing The Chain



#### WARNING!

Never attempt to install, replace, or adjust the chain with the engine running.



#### WARNING!

The saw chain is very sharp. Wear gloves to protect your hands when handling.

#### NOTE

For longest chain life, let new or replacement chain loops soak in oil overnight before installation.

1. Using the small end of the plug wrench, remove the sprocket cover nut (turn counterclockwise to remove) and remove the sprocket cover. See Figure 16.

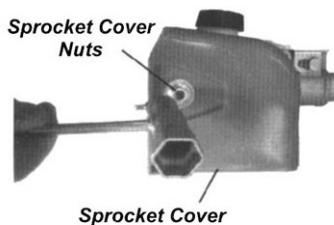

Figure 16

#### CAUTION!

Failure to align the guide bar and chain tensioning pin can cause serious damage to the sprocket cover, guide bar, chain tensioning pin and cutting head assembly.

2. Place the guide bar over the guide bar adjustment stud on the cutting head assembly. Align the chain tensioning pin with the hole in the guide bar. See Figure 17.

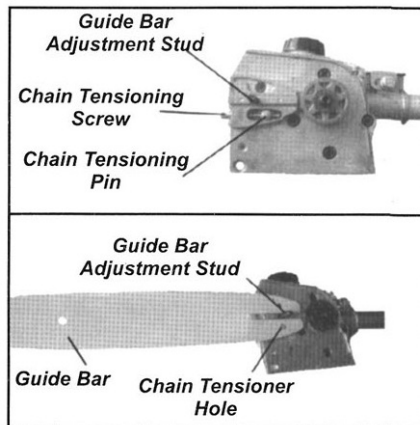

Figure 17

3. Install the chain loop over the drive links within the guide bar groove, and then align the chain over the drive sprocket. Make sure the cutter are properly oriented as shown in Figure 18. If chain installation is difficult or if the chain appears too tight, refer to the section "Adjusting the Chain" on the next page.

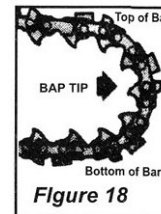

Figure 18



#### WARNING!

Never operate the pole pruner Without the sprocket cover installed.

4. Install the sprocket cover over the bar stud. Using finger-pressure only, install the sprocket cover nut.
5. Refer to the next page for chain adjusting procedures.

## Adjusting the Chain



### WARNING!

Never attempt to install, replace, or adjust the chain with the engine running.



### WARNING!

The saw chain is very sharp. Wear gloves to protect your hands when handling.

### CAUTION!

A loose chain can jump off the guide bar causing damage to the chain and associated equipment. Always make sure the chains is properly adjusted; check more often when you are breaking in a new chain.

### IMPORTANT

Proper chain adjustment is essential for maximum performance, long chain life, and operator safety. Always inspect chain tension before operating the pole pruner.

1. Place the pole pruner on a clean, flat Surface. (For readjustment during operation, shut down the engine, then allow the guide bar and chain to cool before proceeding with the adjustment procedure.

2. Loosen the sprocket cover nut with a Plug wrench (Figure 19).

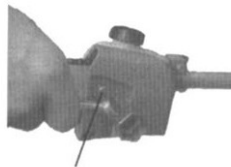
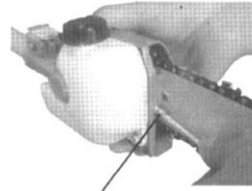

Figure 19

Sprocket Cover Nut

3. Lift the nose of the guide bar while turning the chain tensioning screw. See Figure 20.



Chain Tensioning Screw

Figure 20

- Clockwise to tighten the chain
- Counterclockwise to loosen the chain.

4. Pull the chain by hand along the top of the guide bar several times from the engine to the bar's tip. The chain should feel snug but still pull freely. See Figure 21.

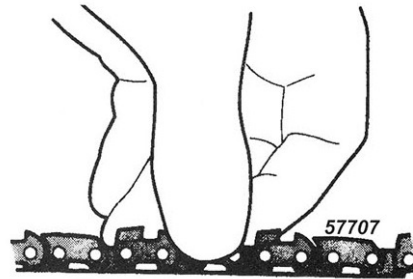

Figure 11

5. Tighten the sprocket cover nut securely while lifting the tip of the guide bar.

6. Inspect the chain for correct adjustment (more frequently with a new chain). The chain should feel snug but still pull freely.

## Chain Oiler



### WARNING!

Never fill the oil reservoir nor adjust the oiler with the engine running.

### IMPORTANT!

The service life of the chain and guide bar is affected by the chain and guide lubricant. Using superior lubricant such as genuine Bar and Chain Oil will help ensure a long service life. For cold weather operation, mix bar and chain oil with an equal part of kerosene.

### Filling The Oil Reservoir

The oil reservoir has a capacity sufficient to provide about 40 minutes of cutting time (when set to deliver the minimum flow rate).

1. Place the pole pruner on a clean, flat surface with the oil filler cap facing up. See figure 22. Wipe off any debris from the oil cap and from around the oil filler neck.

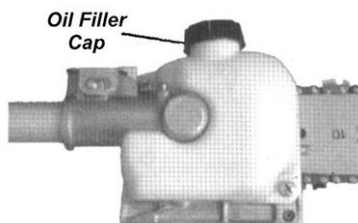

Figure 22

2. Remove the oil filler cap and fill the reservoir with bar and chain oil, then replace the cap.

3. Wipe up spilled oil from the unit before restarting the pole pruner.

## Adjusting Oil Flow Rate

### CAUTION!

An increase in bar oil flow rate will speed oil consumption, requiring more frequent checks on the oil reservoir. To ensure sufficient lubrication, it may be necessary to check the oil level more frequently than at fuel tank refills.

The guide bar and chain are lubricated automatically by a pump that operates whenever the chain rotates. The pump is set at the factory to deliver a medium flow rate, but it can be adjusted in the field. A temporary increase in oil flow is often desirable when cutting things like hardwood or wood with a lot of pitch. Adjust the pump as follows:

1. Stop the engine and make sure the stop switch is in the STOP position.
2. Place the unit in its side with the oil Reservoir up. See Figure 23.

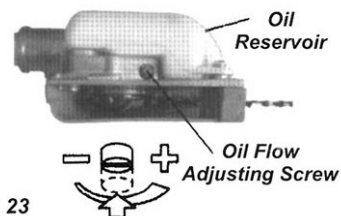

Figure 23

### CAUTION!

The oil flow adjusting screw must be pressed in slightly in order to turn. Failure to do so could damage the Pump and screw.

3. With a screwdriver, push in on the oil flow rate adjusting screw and turn in the desired direction (there are three incremental settings):

- Clockwise-decrease lubrication.
- Counterclockwise-increase lubrication

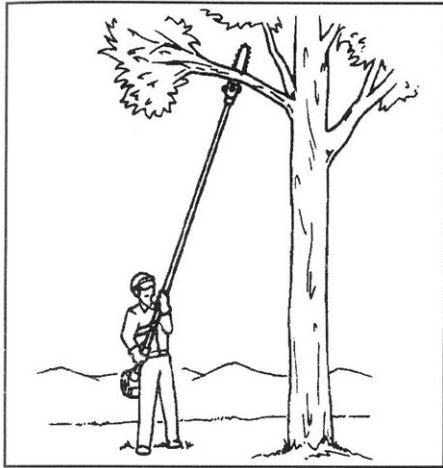

Typical applications  
Standard cut:  
The most convenient working position is a tool angle of 60°, but any other angle may be used to suit the situation concerned.

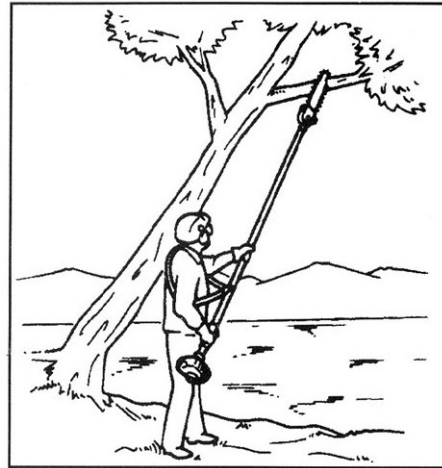

Cutting above obstacles:  
Thanks to the unit's long reach it is possible to prune branches that are overhanging obstacles, such as rivers or lakes.  
The tool angle in this case depends on the position of the branch.

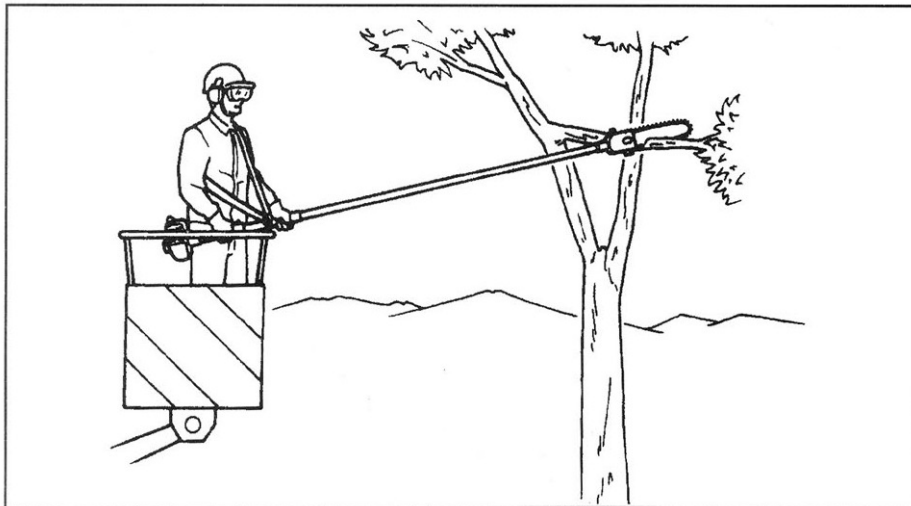

Cutting on a work platform:  
The unit's long reach enables cutting to be performed next to the trunk without the risk of the work platform damaging other branches.  
The tool angle in this case depends on the position of the branch.

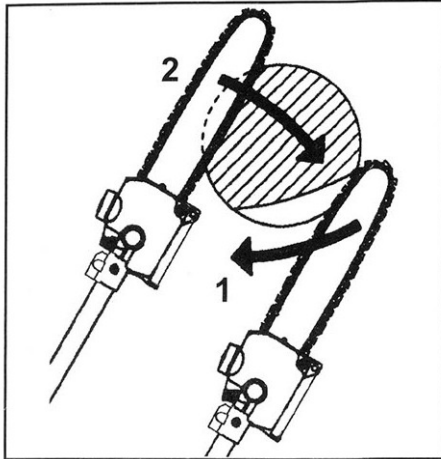

#### Working techniques

##### Relieving cut:

To avoid tearing the bark, kickback or pinching the bar when pruning thick branches the bar when pruning thick branches, always start by performing a relieving cut (1) on the underside of the branch.

To do this apply the cutting attachment and pull it across the bottom of the branch as far as the bar nose. Perform the cross-cut(2).

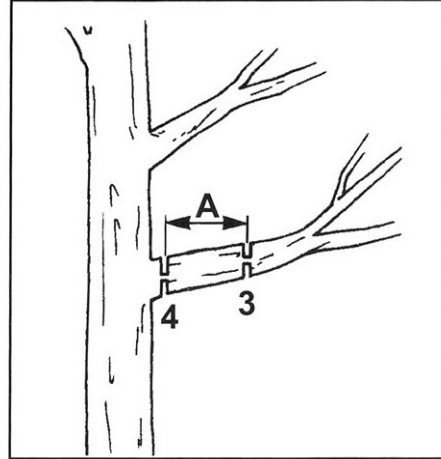

##### Flush-cutting thick branches:

If branch diameter is more than 10cm (4"), first perform undercut(3) and cross-cut at a distance(A) of about 25cm (10") from the final cut. Then carry out the flush-cut(4), starting with a relieving cut and finishing with a cross-cut.

## 50-hour Maintenance

Every 50 hours of operation (more frequently in dusty or dirty conditions):

- Remove and clean the cylinder cover and clean dirt and debris from the cylinder cooling fins.
- Remove the sprocket cover and inspect the sprocket for excessive dirt, debris, or wear. Remove the guide bar and clean out the guide bar groove. If the sprocket is excessively worn, replace it with a new one. See Figure 36.

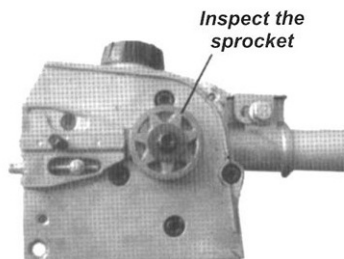

Figure 36

- Lubricate the gearcase. To perform this operation, first remove the gearcase from the upper outer tube as follows (Figure 37):

1. Follow “Disassembling the pole sections” section to remove the upper tube from the gearcase.

2. Using a lever-type grease gun, pump lithium-base grease (about 10 grams) into the grease fitting until you see old grease being purged from the gearcase, which can be seen in the outer tube cavity. Clean up excess grease, then reassemble the gearcase onto the outer tube.

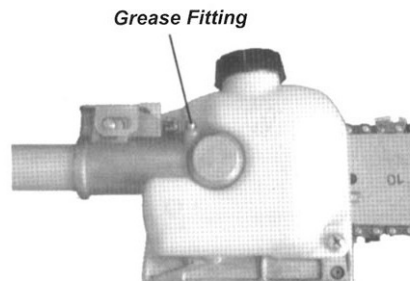

Figure 37

Old grease being purged from the gearcase, which can be seen in the outer tube cavity. Clean up excess grease, then reassemble the gearcase onto the outer tube.

### CAUTION!

Make sure you do not pierce the fuel line with the end of the hooked wire. The line is delicate and can be damaged easily.

- Use a wire hook to extract the fuel filter from inside the fuel tank (Figure 38). Inspect the fuel filter element for signs of contamination. Replace it with a new one if required. Before reinstalling the filter, inspect the fuel line. If you find damage or deterioration, remove the unit from service until it can be inspected by a trained service technician.

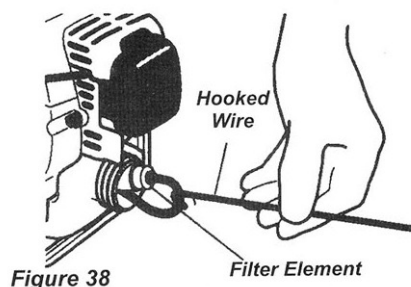

Figure 38

## Sharpening the Chain

When the cutting edges of the blade become dull, they can be re-sharpened with a few strokes of a file.

In order to keep the blade in balance, all cutting edges must be sharpened equally. In addition, inspect the chain for correct adjustment (more frequently with a new chain). The chain should feel snug but still pull freely. See Figure 40.

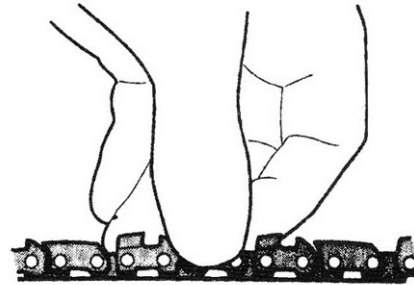

Figure 40

Sharpening Instructions (Fig.41)

### IMPORTANT!

File all cutters to the same angle and depth! Unequal filing may cause the saw to vibrate or cut erratically!

1. Using a 4.5mm round file, sharpen all cutters to a 30° angle. Make sure that one fifth (20%) of the file's diameter is always held above the cutter's top plate.

#### NOTE

For consistent filing angles, use a filing guide such as Oregon® p/n 31692 or equivalent.

2. After all cutters are sharpened, use a depth gauge joiner (Oregon p/n 106738 or equivalent) to measure the height of each depth gauge.

3. As required, lower the depth gauges to a height of 0.5mm. Use a flat file; Oregon p/n 12211 or equivalent.

4. After all depth gauges have been adjusted, use a flat file to round each depth gauge leading edge to its original curvature and angle.

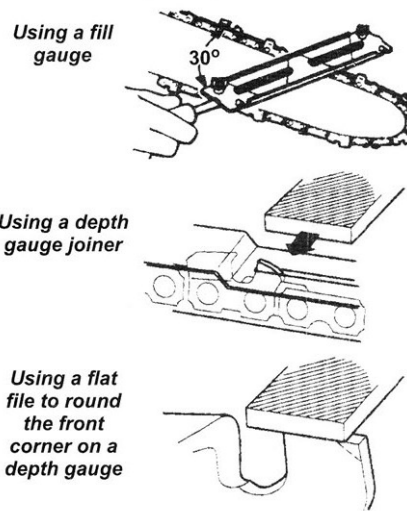
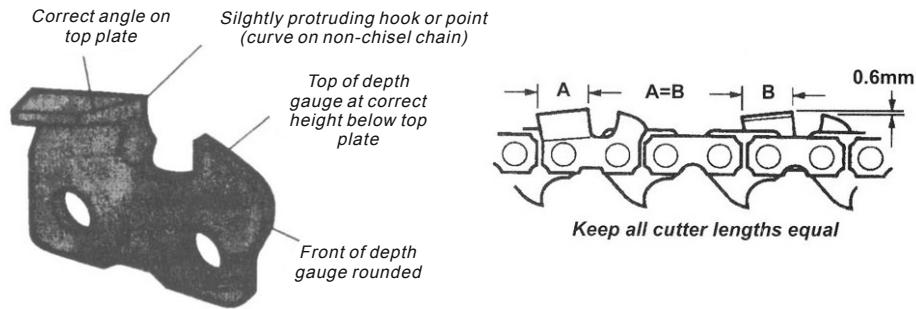

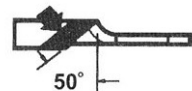

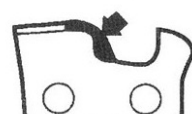
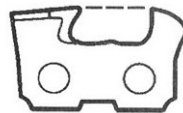



Figure 41

## Correct Filing Technique



## Filing Problems

<p><b>Top plate angle less than recommended</b></p>  <p><i>20°</i></p>	<p><b>Top plate angle more than recommended</b></p>  <p><i>50°</i></p>
<p><b>Hook in side plate cutting edge</b></p> 	<p><b>Back slope on side plate cutting edge</b></p> 
<p><b>High depth gauge</b></p> 	<p><b>Low depth gauge</b></p> 



## HEDGE TRIMMER



### WARNING!

- Never transport the articulated hedge trimmer or set it down with the engine running could be accidentally accelerated causing the blades to oscillate.
- Make sure the blade cover is in the place when transporting and storing the articulated hedge trimmer
- When carrying an articulating hedge trimmer, the blade of the cutting attachment must be in the transport position see Figure 1.



Figure 1

### CAUTION!

- Always maintain the articulated hedge trimmer according to this owner's manual and follow the recommended scheduled maintenance
- Never modify or disable any of the hedge trimmer's safety devices.
- Always use genuine parts and accessories when repairing or maintaining this machine
- Do not make unauthorized modifications to the articulated hedge trimmer
- When transporting the hedge trimmer in a vehicle, tie it down securely to prevent fuel spillage or damage to the machine.
- Always clear your work area of trash or hidden debris to help ensure good footing
- Keep the cutters sharp and properly adjusted
- Keep the articulated hedge trimmer as clean as possible. keep it free of loose vegetation, mud, debris, etc.

## Product description

---

### Prior to assembly

Using figure 3 as a guide, familiarize yourself with the attachment of long reach hedge trimmer and its various components.

Understanding your machine helps ensure top performance, longer service life and safer operation.

Before assembling, make sure you have all the components required for a complete unit:

- Cutter assembly
- Cutter blade cover
- Hand protector clamp screw nut
- Caution labels
- Owner's manual
- Tool kit for routine maintenance

Carefully inspect all components, Making sure they are not damaged

### IMPORTANT

The terms "left", "left-hand", and "LH" "right", "right-hand", and "RH", "front" and "rear" refer to directions as viewed by the operator during normal operation.



### WARNING!

Do not make unauthorized modifications or alterations to your articulated hedge trimmer or its components.

## Installing the Hedge Trimmer Cutter Assembly



### WARNING!

The cutter blades are very sharp. Do not handle the cutter assembly unless the protective blade cover is in place.

### IMPORTANT

Always wear gloves when working with or near the cutter assembly.

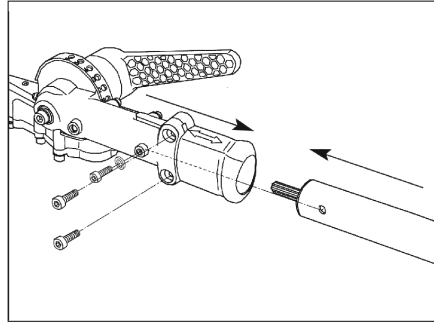

1. Remove the output shaft from the rubber sleeve.
2. Insert the output shaft into the gearbox, align the hexagonal screws and then tighten on both sides, as shown in the illustration.
3. Working head rotation:  
Only change the position of the head when the engine is not operating.
  1. Pull back the lock collar as shown in the illustration.
  2. Select the required working angle for the hedge trimmer head, rotating the side lever.

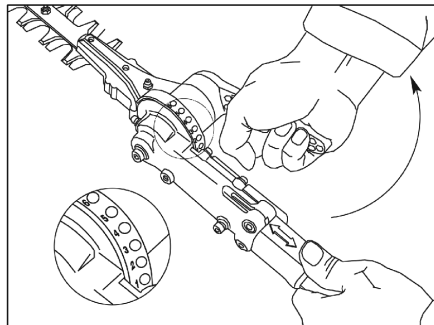

4. Gearbox Grease
  1. After 25 hours run time, grease the gearbox.
  2. Use an injection pump at the designated gearbox nozzle points, as shown.
  3. Gearbox grease recommended:  
OEST LT200EP

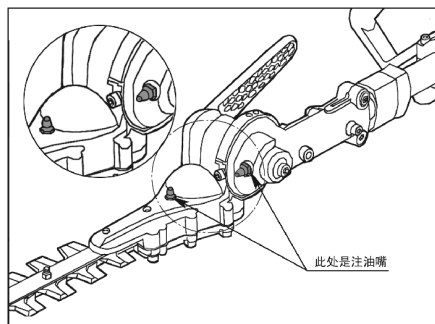

## Safety Operation

This machine is designed especially for trimming hedge.  
Never use this machine for any other purposes. Never try to cut stones, metals, plastics or any other hard objects.  
Using for other purposes than trimming hedge may damage the machine or cause serious injury.

### Preparations

- Wear suitable protective clothing and equipment-see section "Safety Precautions."
- Choose the best work position for safety against the falling object (branch etc)
- Start the engine.
- Put on the strap.

Never stand directly underneath the branch you are cutting-be wary of falling branches. Note that a branch may spring back at you after it hits the ground.

### Working position:

Hold the control handle with your right hand, and the shaft with your left hand. Your left arm should be extended to the most comfortable position.

## Applications Preparations

Use lopping shears to cut out thick branches first.

### Cutting sequence

If a radial cut is necessary, cut a little at a time in several passes.

### Cutting techniques

#### Vertical cut:

Swing the cutting blade up and down in an arc as you move along the hedgeuse both sides of the cutting blade.

#### Horizontal cut:

Hold the cutting blade at an angle of  $0^\circ$  to  $10^\circ$  as you swing the hedge trimmer horizontally.

Swing the blade in an arc towards the outside of the tedge so that the cuttings are swept on to the ground.

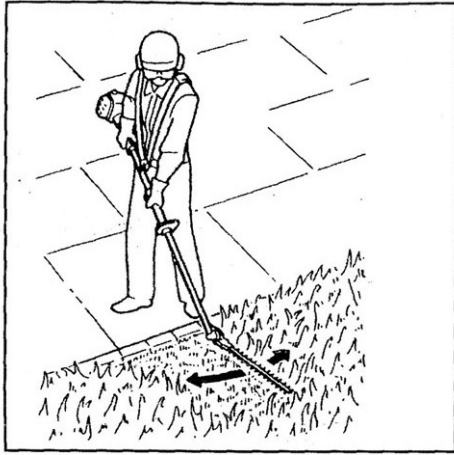

**Horizontal cut**

Cutting close to ground from a standing position, e.g. low shrubs.

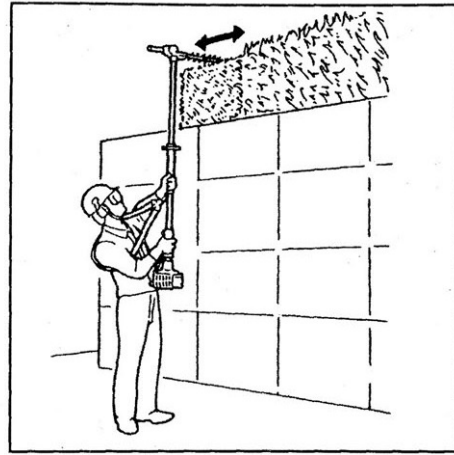

**Overhead cut**

Hold the shaft upright with a 90° blade angle to cut an upper surface of a hedge.



**Vertical cut**

Cutting without standing directly next to hedge, e.g. flowerbed between operator and hedge.



**Horizontal cut**

Cutting without standing directly in front of the hedge, e.g. reaching over a flowerbed.

## Operating the Articulated Hedge Trimmer

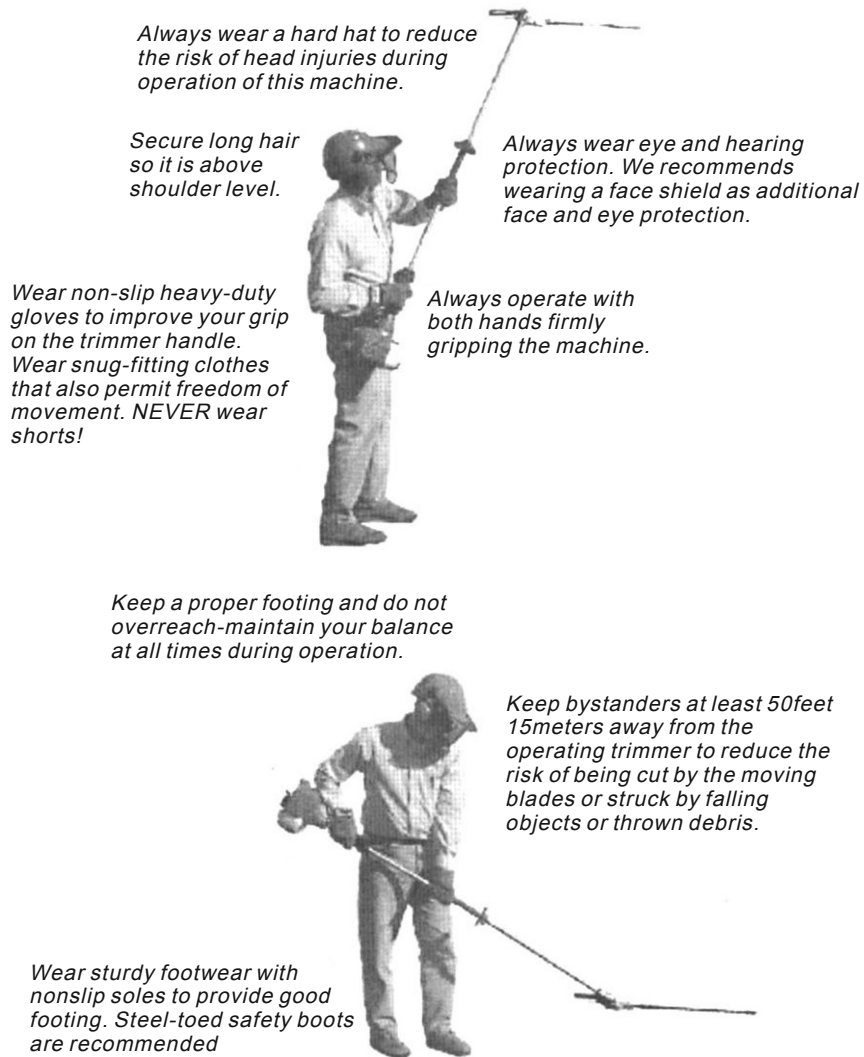

**Figure 1**

---



**EC-DECLARATION OF CONFORMITY**

<b>EC Declaration of Conformity</b>	
We herewith declare,	Cobra Garden Machinery Henton & Chattell Ltd, London Road, Nottingham NG2 3HW United Kingdom
That the following machine complies with the appropriate basic safety and health requirements of the EC Directive based on its design and type, as brought into circulation by us.	
In case of alteration of the machine, not agreed upon by us, this declaration will lose its validity	
Machine Description:	26.3 cm <sup>3</sup> Multi-cutter
Machine Type:	MT270K (PNM270K)
Displacement	26.3 cm <sup>3</sup>
Max, Cutting width	Brush cutter 255mm, Grass trimmer 420mm, Pruner 295mm, Hedge trimmer 620mm
Measured sound power level:	98dB(A)
Guaranteed sound power level:	110dB(A) Notified Body for EC Directive: Intertek Testing Services Shanghai Building No. 86, 1198 Qinzhou Road(North), Shanghai 200233 China
Applicable EC Directives	2006/42/EC                      2004/108/EC 2000/14/EC                      97/68/EC
Applicable Harmonized Standards	EN ISO 11680-1:2011    EN ISO 11806-1:2011 EN ISO 10517:2009 +A1:2013 The conformity assessment procedure followed was in accordance with Annex III of the Directive 2000/14/EC
Authorized Signature/Date	  Peter J. Chaloner    12-06-2014
Title of Signatory	Managing Director
Name and address of the person authorised to compile the technical file	Cobra Garden Machinery Henton & Chattell Ltd, London Road, Nottingham NG2 3HW United Kingdom