

## General Warranty Conditions

The warranty applies to the original purchaser from the date of purchase and covers manufacturing faults and defects only. If an item should fail as a result of a manufacturing fault or defect under normal domestic use, the manufacturer at their discretion will repair, refinish or replace the failed item.

The manufacturer reserves the right to substitute failed items with a similar product should the model or colour no longer be available. Any replacement will be for the failed item only, not a complete set. The original warranty period is not extended in the event of a repair, refinish or replacements.

In the event of a failure, it is the customer's responsibility to return the item to the store of purchase along with a copy of the receipt. LG Outdoor will confirm that the customer has registered their warranty. Warranty specifically excludes general wear and tear, rusting of steel components and parts, corrosion, commercial use and damage caused as a result of failure to observe reasonable care, maintenance and assembly instructions for both furniture and hardware.

**This product comes with a Limited Warranty which covers the following:**

- \* 3 Year Limited Warranty - Aluminium Frames - which excludes damage to the finish caused by corrosion, scratching, pitting, fading or oxidisation
- \* 3 Year Limited Warranty - Weave - which excludes scratching of wicker finish and dis-colouration

**For all other components not covered by the above a standard 12-month warranty will apply**

**To register your warranty please visit [lgoutdoor.co.uk/furniture-warranty](http://lgoutdoor.co.uk/furniture-warranty) within 28 days of purchase**

**LEISUREGROW**

Dewmead Farm  
New Inn Road  
Hinworth  
SG7 5HG  
[salessupport@leisuregrow.com](mailto:salessupport@leisuregrow.com)



## ASSEMBLY AND CARE INSTRUCTIONS

### Oslo 115cm Dining Table



**This is an important document.  
Please retain for future reference.  
Please keep your receipt of purchase. Please note we are unable  
to process any warranty claim without proof of purchase.**

## Care Instructions

- This tabletop is made from hand-brushed, wood-effect aluminium. While it has been treated with a protective lacquer during production, please avoid contact with sharp or abrasive objects
- Always ensure the Parasol Insert is in place before installing a Parasol
- When using a Parasol with this table, ensure a suitably weighted Parasol Base is used and never leave the Parasol up while unattended
- Please keep away from sources of extreme heat and naked flames
- Do not sit or stand on this table
- We recommend cleaning this product periodically with warm, soapy water and a cloth or non-abrasive brush. Do not use harsh or abrasive chemicals
- To keep your product looking its best, we would always recommend covering with an LG Outdoor Furniture Cover when not being used for longer periods. Throughout the winter months either bring indoors or cover as above. Failure to do so may invalidate your warranty

## Necessary Tools Supplied

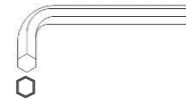

You will find a pack within this box tied to a red ribbon which contains the fittings.

**WARNING** – the fittings pack contains **SMALL ITEMS** which are a potential choking hazard and should be kept away from children at all times.

## Assembly Requirements

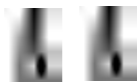
Number of people required to assemble	
Approximate Assembly time	20 minutes





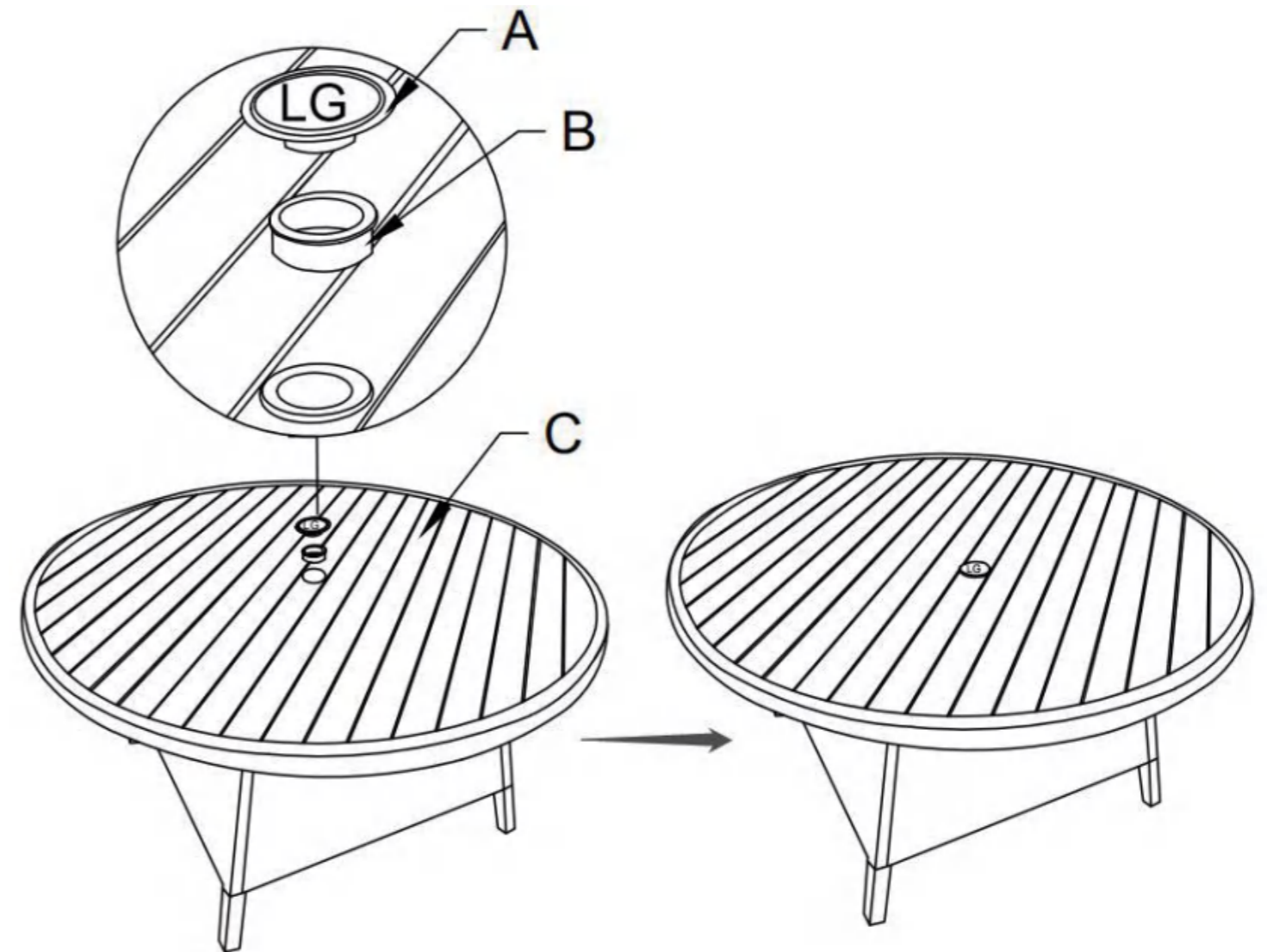





**Read this leaflet in full before commencing assembly.**

## Step 3

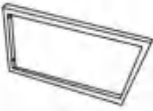

PLEASE ENSURE ALL FIXINGS ARE LEFT LOOSE DURING ASSEMBLY BUT ARE SECURELY TIGHTENED UPON COMPLETION.

# Part List Supplied

Ref	Part	Image	Qty	Ref	Part	Image	Qty
A	PARASOL BUNG		1	F	METAL WASHER (D6)		12
B	PARASOL REDUCER		1	G	INNER HEXAGONAL SCREW(M6*45)		8
C	TABLE TOP		1	H	INNER HEXAGONAL SCREW(M6*20)		4
D	TABLE BASE-1		2	I	PLASTIC INNER HEXAGONAL BOLT CAP(M6)		12
E	TABLE BASE-2		2	J	ALLEN KEY		1

# Assembly Instructions

## Step 1

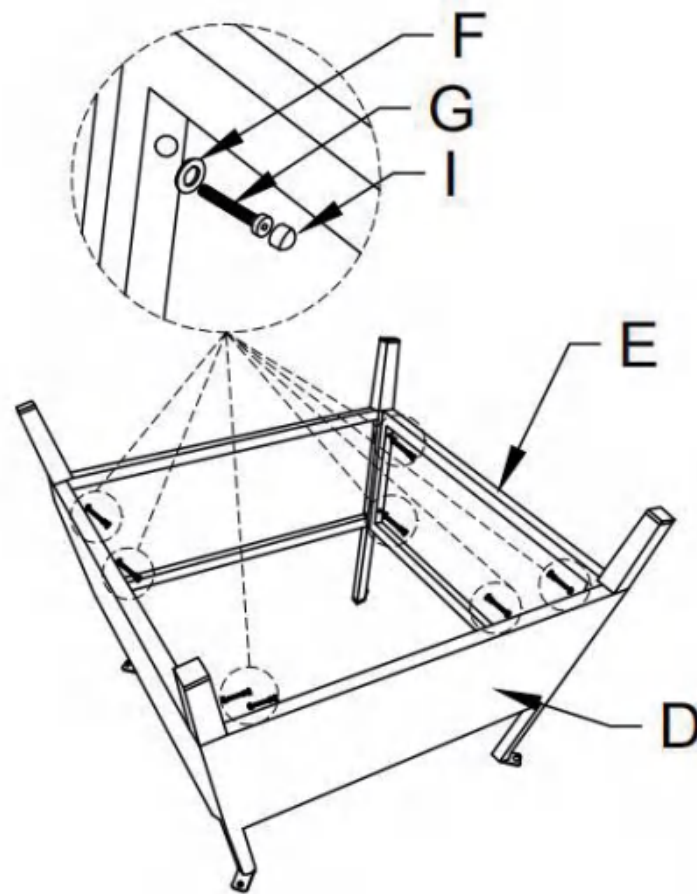

## Step 2

