



Assembly Instructions

Aries Lounge Chair

(69801096)







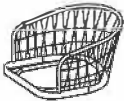

PLEASE RETAIN THIS DOCUMENT ALONG WITH YOUR
PROOF OF PURCHASE FOR FUTURE

Congratulations on your recent purchase of your beautiful Hartman furniture. We hope it brings you bountiful special moments with friends and family for many years to come. Please follow these simple steps to build your furniture. We also have a very useful video available online to assist with the assembly, please visit www.hartmanuk.com

TOP TIPS

- Please read these instructions carefully before assembly, for further assistance please view our assembly video online for an easy step by step demonstration
- Aluminum is a soft metal and over tightening may strip the thread or break the part, please loosely assembly your furniture before tightening to secure.
- Please **do not** use power tools, please use the allen key provided in the bolt pack
- Please allow 1 hour for assembly
- This furniture can be assembled with 1 persons; however, you may need someone to assist you when turning the furniture over into position.

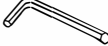
PARTS LIST

Component's					Fixings				
Parts List	Parts Picture	Description	Qty	Part no	Parts List	Parts Picture	Description	Qty	Part no
A		Frame	1	69801096A	F		Bolt (M6X20)	12	1091162
B		Front leg	2	69801096B	G		Washer (M6*φ 14)	12	1241163
C		Rear leg	2	69801096C	H		Platic bolt cap (M6)	12	1061167
D		Seat cushion	1	5ARSC001M N	I		Allen Key (M6)	1	1010162
E		Back cushion	1	5ARBC001M N	J		plastic footpad	4	2PNS007A

STEP1: LEG ASSEMBLY

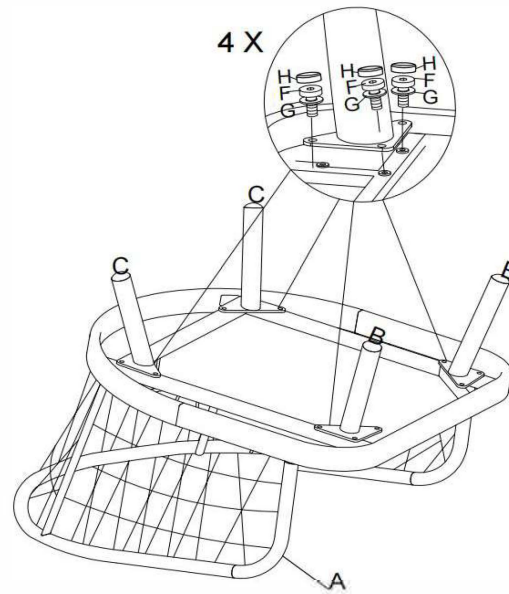

STEP1: Attach Front leg (B) , Rear leg (C), to the Frame (A), using the Bolt M6X20 (F) and Washer (G). Tighten the bolts and cover with the Plastic bolt cap (H)

STEP2: FINISHING

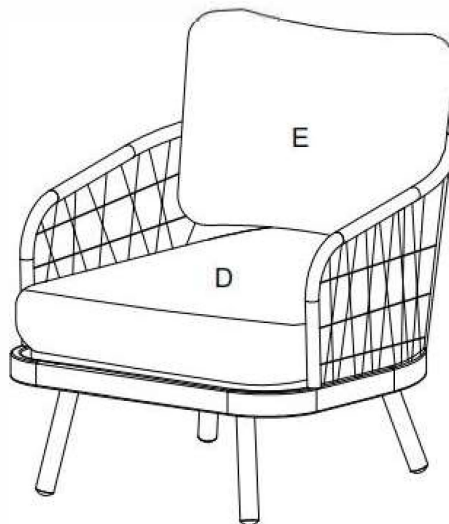

STEP2: Turn the sofa over and place the Seat cushion (D) and the Back cushion (E) onto the sofa