



Assembly Instructions

Ezra 6 Seat Rectangular Table (Product Codes: 69124014)

**PLEASE RETAIN THIS DOCUMENT ALONG WITH YOUR
PROOF OF PURCHASE FOR FUTURE**









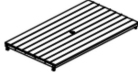

Congratulations on your recent purchase of your beautiful Hartman furniture. We hope it brings you countless special moments with friends and family for many years to come.

Please follow these simple steps to build your furniture. We also have a very useful video available online to assist with the assembly, please visit www.hartmanuk.com

TOP TIPS

- Please read these instructions carefully before assembly, for further assistance please view our assembly video online for an easy step by step demonstration.
- Aluminium is a soft metal and over tightening may strip the thread or break the part, please loosely assembly your furniture before tightening to secure.
- Please **do not** use power tools, please use the spanner provided in the bolt pack.
- Please allow 1 hour for assembly.
- This furniture can be assembled with **1** person; however, you may need someone to assist you when turning the furniture over into position.

PARTS LIST

Components					Fixings				
Parts List	Parts Picture	Description	Qty	Part no	Parts List	Parts Picture	Description	Qty	Part no
A		Table Top	1	69124014A	C		M6*40 Bolts	8	2002168
B		Leg	2	69124014B	D		M8*40 Bolts	12	2002183
					E		Small Flat Washers	8	1241162
					F		Big Flat Washers	12	1061162
					G		Small Lock Washers	8	1221162
					H		Big Lock Washers	12	2100048
					I		Spanner	1	2100049
					J		Parasol Bungs & Reducers	3	2100050

STEP 1 & 2: LEG ASSEMBLY - TABLE

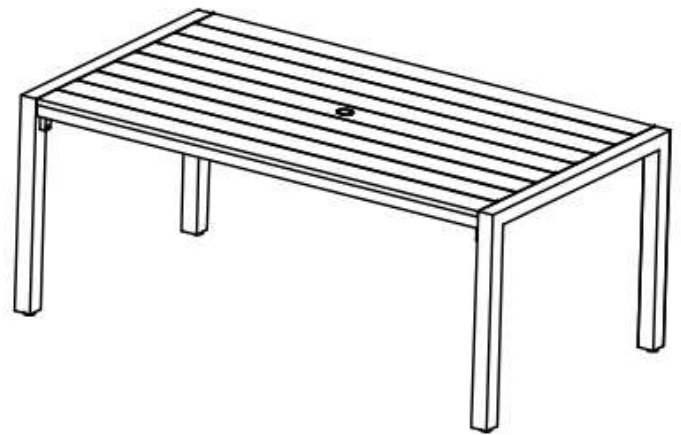
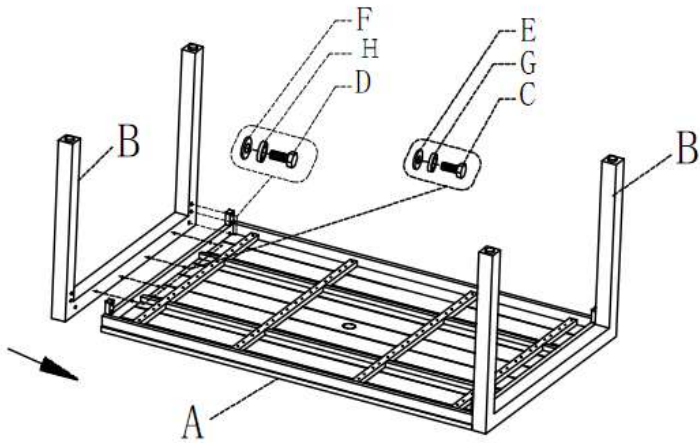

STEP 1: Attach leg frame (B) to table top (A) with big bolts (D) & big flat washers (F) & big lock washer (H) for the two outer bolt holes and the small bolts (C), small flat washers (E) & small lock washer (G) for the four middle bolt holes, using spanner (J). Tighten all bolts using spanner (J) one by one being careful not to over tighten any as this will cause the thread to become damaged.

STEP 2: Turn table top over and place in desired position. Place parasol bungs & reducers (I) in the hole on table top. You can now use the table.